

MOSAIC DISPLAY UNIT

RCM1637U-A

Thanks to the high contrast and wide viewing angle of the RCM1637U-A, which is provided by its unique design technology, this module brings forth new applications in brand new LCD fields. ROHM large-sized LCD units are perfect displays for information or sign boards. As a media for informational display, large-sized LCD units must possess high visibility, wide viewing angles, and other such superior qualities. ROHM large-sized LCDs boast an excellent track record and possess guaranteed functionality for assured satisfaction in a variety of situations.

●Applications

Indoor information board (airport, train station, bus depot), In-hall or in-store display, public message board.

●Features

- 1) Most suitable for the alphabet and number display including German, French and Spanish.
- 2) Wide viewing angle and high contrast.
- 3) Compact and light weight for easy assembly.
- 4) Low power consumption.

●External dimensions (Units : mm)

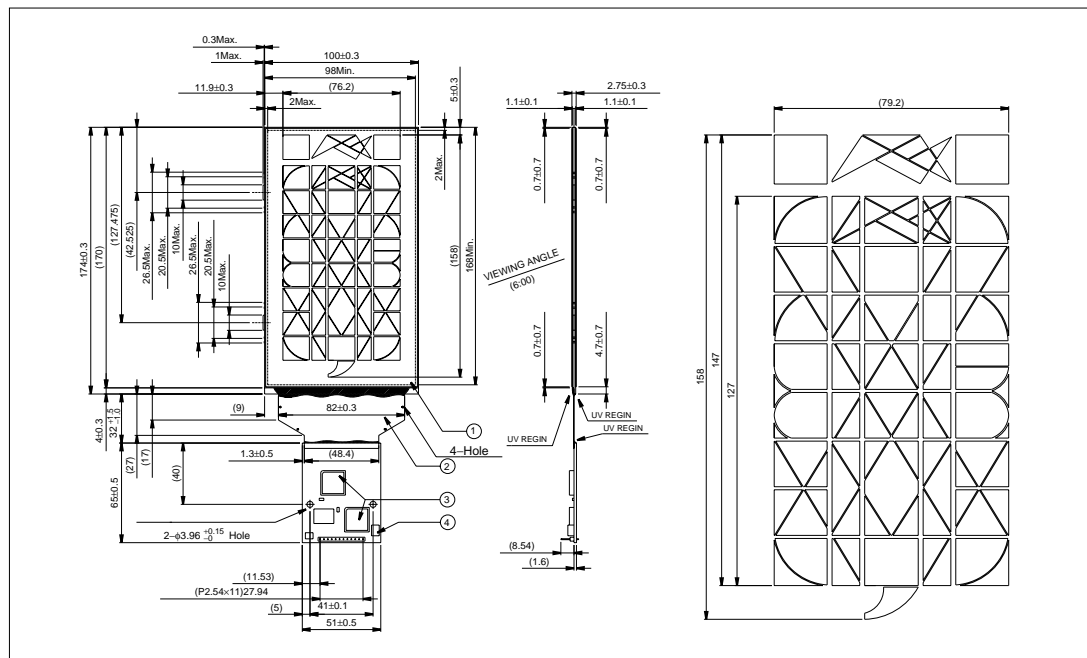

Liquid crystal displays

●Block diagram

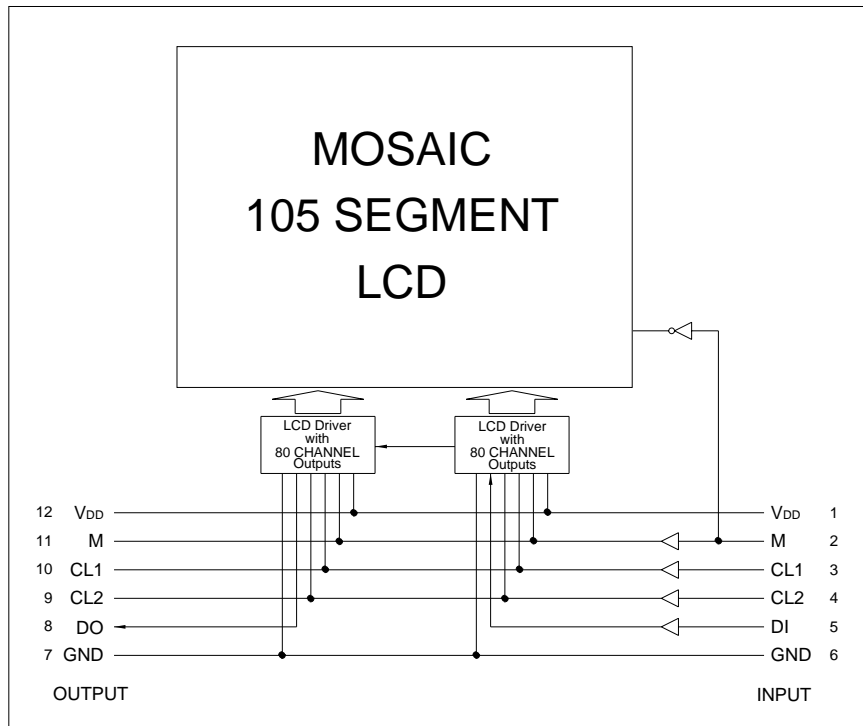

●Pin functions

(1) Input (CN1)

Pin No.	Symbol	IN / OUT	Function
1	V _{DD}	-	Charge 5Volt
2	M	IN	Alternating signal of LCD operating output
3	CL1	IN	Data latch signal (display at descending edge)
4	CL2	IN	Shift resistor signal (displayed at descending edge)
5	DI	IN	Display data signal (1: Lighting 0: Non-Lighting)
6	GND	-	Ground electric potential
7	GND	-	Ground electric potential
8	DO	OUT	Display data signal
9	CL2	OUT	Shift resistor signal
10	CL1	OUT	Data latch signal
11	M	OUT	Alternating signal
12	V _{DD}	-	5Volt

●Pin

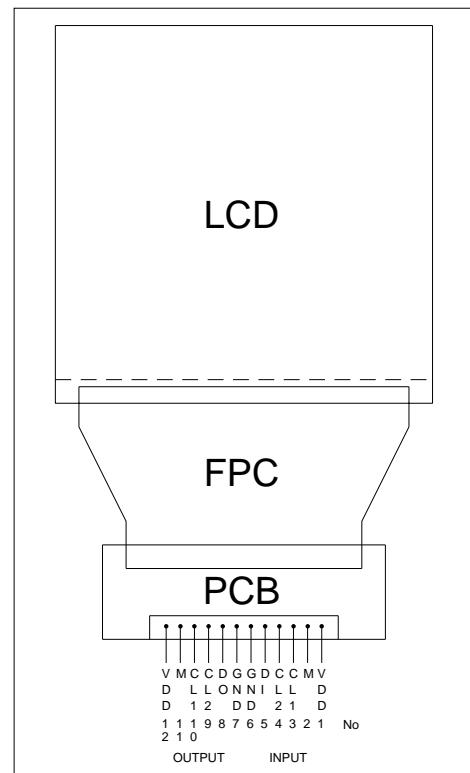

Liquid crystal displays

●Absolute maximum ratings (Ta = 25°C)

Parameter		Symbol	Limits	Unit
Power supply voltage	Circuit	V _{DD}	-0.3 ~ +7.0	V
	LCD operation	V _{DD} -V _{EE}	-0.3 ~ +7.0	V
Input voltage		V _{IN}	-0.3 ~ V _{DD} +0.3	V
Operating temperature		T _{opr}	-20 ~ +70	°C
Storage temperature		T _{stg}	-40 ~ +85	°C

●Electrical characteristics (V_{DD} = 5.0V, GND = 0V, Ta = 25°C)

Parameter	Symbol	Min.	Typ.	Max.	Unit	Conditions
Input high level voltage	V _{IH}	0.8V _{DD}	-	V _{DD}	V	
Input low level voltage	V _{IL}	-	-	0.2V _{DD}	V	
Output high level voltage	V _{OH}	V _{DD} -0.4	-	-	V	I _{OH} = -0.4mA
Output low level voltage	V _{OL}	-	-	0.4	V	I _{OL} = +0.4mA
Input LCD voltage	VLCD	-	5.0	-	V	
Consuming current	I _{DD}	-	-	6.0	mA	f _{CL} = 1MHz, f _M = 100Hz

●AC characteristics (V_{DD} = 5.0V, GND = 0V, Ta = 25°C)

Parameter	Symbol	Applicable terminal	Min.	Typ.	Max.	Unit
Data shift frequency	f _{CL}	CL2	-	-	1	MHz
Clock high level width	t _{CWH}	CL1, CL2	470	-	-	ns
Clock low level width	t _{CWL}	CL2	470	-	-	ns
Data setup time	t _{SU}	DI	120	-	-	ns
Clock setup time 1	t _{SL}	CL2	220	-	-	ns
Clock setup time 2	t _{LS}	CL1	220	-	-	ns
Data hold time	t _{DH}	DI	120	-	-	ns
Clock rise / fall time	t _{ct}	CL1, CL2	-	-	50	ns
Output delay time	t _{pd}	DO	-	-	250	ns
Alternating signal	f _M	M	50	100	150	Hz

●Timing characteristics

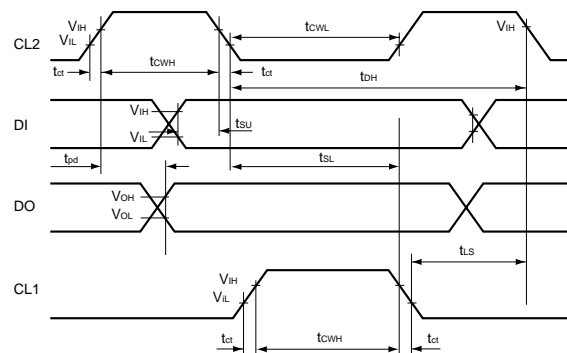

Fig.1

Liquid crystal displays

●Optical characteristics (Ta = 25°C)

No.	Parameter	Symbol	Temperature (°C)	Min.	Typ.	Max.	Unit	Note
1	Response time	Tr	0	-	400	800	ms	(Note 2)
			25	-	65	100		
		Td	0	-	150	300		
			25	-	45	100		
2	Viewing Range	Vertical	θ	25	0	-	deg	(Note 3) K≥3
		horizontal	φ	25	90	-		
3	Contrast ratio	K	25	35	50	-	-	φ = 180°, θ = 10°

(Note 1) Driving pulse
Static drive

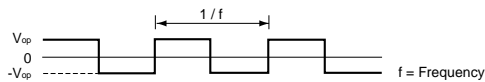

- (1) φ : Angle which an observer will become Z Z'.
- (2) θ : When observers position is considered as flat X,Y over a projector angle which makes Y Y'.
- (3) Greatest viewing angle direction : Time axis which represent best contrast ratio.

(Note 2) Response time definition and condition

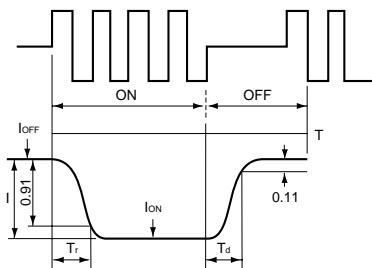

Tr : The time required to activate from non-selecting wave pattern to selecting wave pattern and to change 90% for darken.

$$\phi = 180^\circ, \theta = 10^\circ$$

Td : The time required to activate from selecting wave pattern to non-selecting wave pattern and to change 90% for darken.

$$\phi = 180^\circ, \theta = 10^\circ$$

(Note 3) Definition of viewing angle (φ, θ)

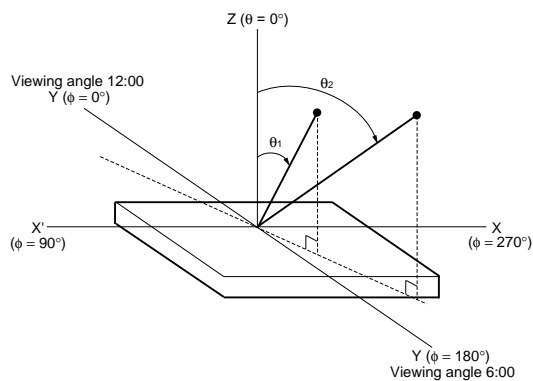

(Note 4) Definition of contrast ratio

<Definition>

$$\text{Contrast ratio} = \left(\frac{\text{Luminous intensity at off segment transmissivity}}{\text{Luminous intensity at on segment transmissivity}} \right)^n$$

Positive type n = 1, Negative type n = -1

<Measurement conditions>

Drive conditions: Specific value condition

Viewing angle: φ = 180°, θ = 10°

(Note 5) Optical measuring equipment theory plan

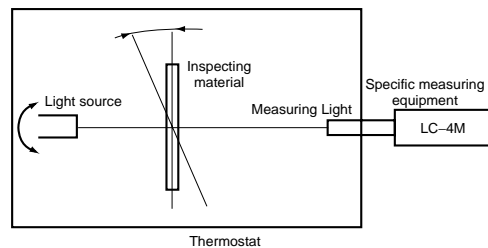

Liquid crystal displays

● Data format (data and display mapping)

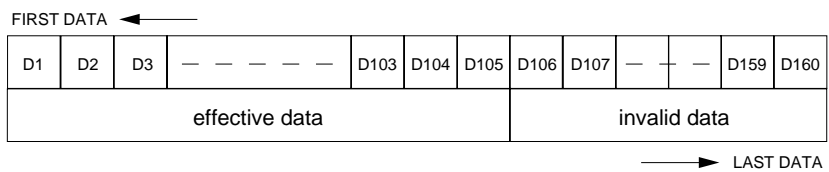
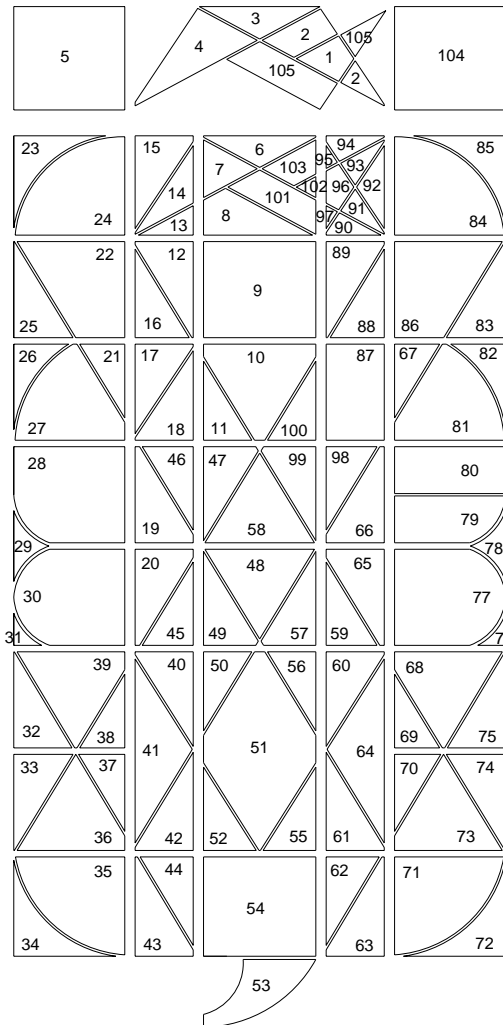

Liquid crystal displays

●Timing chart

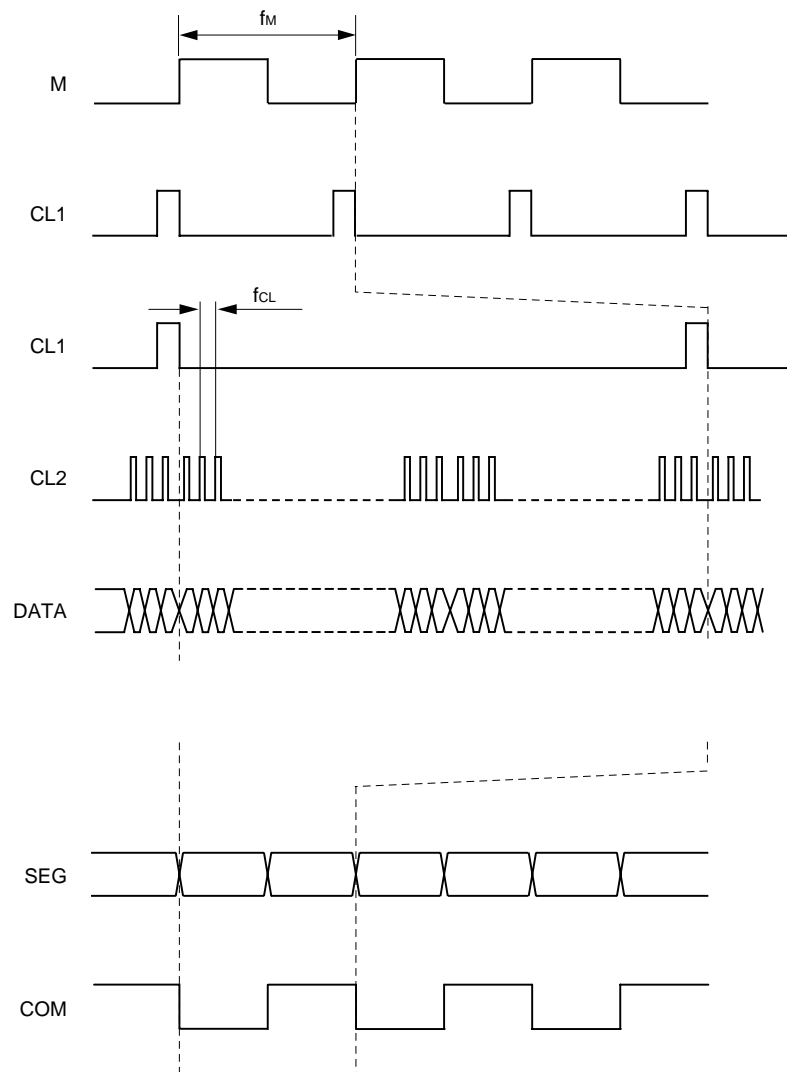

Note) LCD operation output voltage

M	DATA	COM Voltage	SEG Voltage
1	1	GND	V_{DD}
1	0	GND	GND
0	1	V_{DD}	GND
0	0	V_{DD}	V_{DD}

Liquid crystal displays

●Operation notes

(1) Handling instruction

- Attention must be paid to avoid external shock, which will cause operational failure.
- Polarizer on the surface is gentle and can be damaged easily by scratch, thus please take extra care when handling. For surface termination, please wipe off with alcohol.
- The liquid used in the LCD panel is a harmful substance and must not be licked or allowed. If you touch this liquid, wash it out completely.
- Do not touch IC lead and terminal.
- Do not expose to direct sunlight for a long period of time and if it will be used at direct sunlight, recommend to use UV cut filter.
- For storage please avoid in high temperature, high humidity. When long-term storage is required, keep the panels in low temperature (5°C ~ 25°C) and low humidity.
- To prevent TAB damage, TAB bent time must be up to twice.

(2) Operational instruction

- Please do not connect or take away the LCD module to the system in the condition of power on.
- Please input signal after LCD module power is turned on when turning off. Please turn off from input signal. In worst case IC can be broken by ratch up phenomenon.

(3) Mounting instruction

- In the circuit CMOS-IC is used. Please be careful for ESD.
- Protection sheet is put on LCD module surface and back side. At removing the sheet, electric static is generated. So it must be removed slowly and recommend to use Ion blower etc.

(4) Cautions for LCD with FPC

- Do not bend nor pull FPC.
- Do not hold FPC with fingers directly nor suspend FPC.
- When bending FPC, keep 5mm from the edge of glass (FPC joint) and bend toward Mother board side.

(5) Production

- Production in Japan or China.